



### TECEdrainprofile shower profile with coloured surface

Article number: 670803

Length: 800 mm

Width: 55 mm

Colour: Brushed red gold

DU 1: 1 pc.

#### Description:

Shower profile for shower drainage, for installation in tile adhesive above the screed and seal.

The finishes are colour matched to the TECESquare II metal toilet flush plates.

Consisting of:

- Shower profile that can be cut to length with internal incline for improved water drainage and self-cleaning effect
- Shower profile can be shortened to  $\geq 500$  mm
- Profile cover with "Push Function" for removal by hand, durable to load class K3 - maximum test load 300 kg
- Shower profile and profile cover, made of stainless steel material 1.4301 (304) with coloured PVD coating
- Connection pieces for connection with a TECEdrainprofile drain
- Grip elements for easy installation and solid connection with the tile adhesive
- For floors from 8-25 mm (incl. adhesive bed)
- For flush to the wall installation for wall coverings from 10 mm (incl. adhesive bed)
- For installation at the wall (flush to the wall) or at any specific distance from the wall

#### Please order separately:

- TECEdrainprofile drain

#### Sales data:

Product name: TECEdrainprofile shower profile, 800 mm, stainless steel, brushed red gold

Commodity group: 608

Product group: 3006080011

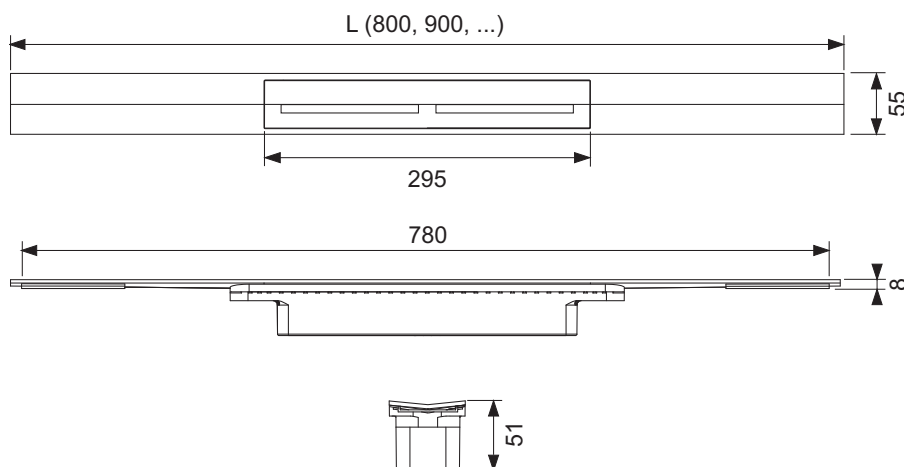

**Spare parts:**

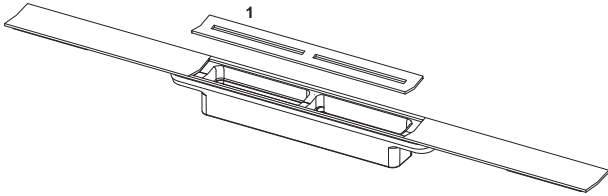

- 1 675014 Profile cover stainless steel, brushed rose gold